



// 10.7. Visserie - Schrauben



Version 2021-1



Des conseils particulièrement pro



bois // portes // panneaux // isolation
toiture // lambris // parquets // terrasses // bardages
quincaillerie // mécanisation // parachèvement



01 VIS UNIVERSELLES UNIVERSALSCHRAUBEN p. 03 s. 03

Galvanisé <i>Verzinkt</i>	TX TX	03-07
Galvanisé <i>Verzinkt</i>	PZ PZ	08-09
Inox A2 <i>Inox A2</i>	TX TX	10-13



02 VIS FAÇADE FASSADENSCHRAUBEN p. 14 s. 14

03 VIS TERRASSE TERRASSENSCHRAUBEN p. 15 s. 15

04 VIS POUR MEUBLES MÖBELSCHRAUBEN p. 16 s. 16

Vis Euro <i>Euroschrauben</i>	16
Vis pour parquet massif <i>Schrauben für massiv Böden</i>	16
Vis pour MDF <i>MDF-Schrauben</i>	16
Vis assemblage meuble <i>Möbel-Montageschrauben</i>	16
Vis à bouchons <i>Schrauben mit Kopflochbohrung</i>	17



05 VIS D'ASSEMBLAGE & RÉGLAGE VERBINDUNGS- & JUSTIER- & PLATTENSCHRAUBEN p. 18 s. 18

06 VIS DE CONSTRUCTION KONSTRUKTIONSSCHRAUBEN p. 19 s. 19

Tête plate et tête fraisée <i>Tellerkopf und Senkkopf</i>	19-21
Tir-fonds <i>Sechskant-Holzschraube</i>	21



07 VIS CHÂSSIS RAHMENANKER p. 22 s. 22

08 VIS GYPROC + FERMACELL GIBSPLATTENSCHRAUBE + FERMACELL p. 23 s. 23

09 ACCESSOIRES ZUBEHÖR p. 25 s. 25



Veillez noter que les couleurs, les photos, les illustrations et visuels de notre catalogue sont à titre indicatif et non contractuels.

Vis universelle

Universalschrauben

Vis universelle

Filet total, torx

Universalschraube

Vollgewinde, Torx



Info	Longueur	Qté/Emb	Code	
	Länge	VPE		
ø 3 mm d1 = 6 mm T10	12 mm	1000	ABCTX3012VG	
		200	ABCTX3012VG1	
	16 mm	1000	ABCTX3016VG	
		200	ABCTX3016VG1	
	20 mm	1000	ABCTX3020VG	
		200	ABCTX3020VG1	
	25 mm	1000	ABCTX3025VG	
		200	ABCTX3025VG1	
	30 mm	1000	ABCTX3030VG	
		200	ABCTX3030VG1	
	ø 3,5 mm d1 = 7 mm T20	16 mm	1000	ABCTX3516VG
			200	ABCTX3516VG1
20 mm		1000	ABCTX3520VG	
		200	ABCTX3520VG1	
25 mm		1000	ABCTX3525VG	
		200	ABCTX3525VG1	
30 mm		1000	ABCTX3530TG	
		1000	ABCTX3530VG	
		200	ABCTX3530VG1	
35 mm		1000	ABCTX3535VG	
		200	ABCTX3535VG1	
40 mm		1000	ABCTX3540VG	
	200	ABCTX3540VG1		
45 mm	200	ABCTX3545VG1		

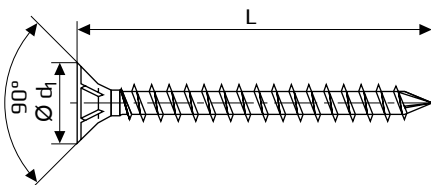

Vis universelle

Filet partiel, torx

Universalschraube

Teilgewinde, Torx



Info	Longueur	Qté/Emb	Code
	Länge	VPE	
ø 3 mm d1 = 6 mm T10	35 mm	1000	ABCTX3035TG
ø 3,5 mm d1 = 7 mm T20	35 mm	1000	ABCTX3535TG
	40 mm	1000	ABCTX3540TG
	45 mm	1000	ABCTX3545TG
	50 mm	500	ABCTX3550TG
ø 4 mm d1 = 8 mm T20	30 mm	1000	ABCTX4030TG
		1000	ABCTX4035TG
	40 mm	1000	ABCTX4040TG
		200	ABCTX4040TG1
	45 mm	500	ABCTX4045TG
		200	ABCTX4045TG1
	50 mm	500	ABCTX4050TG
		200	ABCTX4050TG1
	60 mm	500	ABCTX4060TG
		100	ABCTX4060TG1
	70 mm	500	ABCTX4070TG
		100	ABCTX4070TG1
ø 4,5 mm d1 = 8,8 mm T20	30 mm	200	ABCTX4530TG1
		200	ABCTX4535TG1
	40 mm	500	ABCTX4540TG
		200	ABCTX4540TG1
	45 mm	500	ABCTX4545TG
		200	ABCTX4545TG1
	50 mm	500	ABCTX4550TG
		200	ABCTX4550TG1
	60 mm	500	ABCTX4560TG
		100	ABCTX4560TG1
	70 mm	500	ABCTX4570TG
		100	ABCTX4570TG1
80 mm	200	ABCTX4580TG	
	100	ABCTX4580TG1	

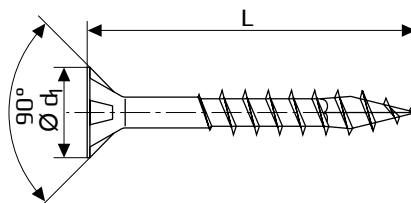

Vis universelle

Vis universelle

Filet total, torx

Universalschraube

Vollgewinde, Torx



Info	Longueur	Qté/Emb	Code
	Länge	VPE	
ø 4 mm d1 = 8 mm T20	16 mm	1000	ABCTX4016VG
	20 mm	1000	ABCTX4020VG
	25 mm	1000	ABCTX4025VG
		200	ABCTX4025VG1
	30 mm	1000	ABCTX4030VG
		200	ABCTX4030VG1
	35 mm	1000	ABCTX4035VG
		200	ABCTX4035VG1
	40 mm	1000	ABCTX4040VG
		200	ABCTX4040VG1
	45 mm	500	ABCTX4045VG
		200	ABCTX4045VG1
	50 mm	500	ABCTX4050VG
		200	ABCTX4050VG1
ø 4,5 mm d1 = 8,8 mm T20	25 mm	1000	ABCTX4525VG
	35 mm	500	ABCTX4535VG
	40 mm	500	ABCTX4540VG
	45 mm	500	ABCTX4545VG
	50 mm	500	ABCTX4550VG
ø 5 mm d1 = 9,7 mm T20	30 mm	500	ABCTX5030VG
	35 mm	500	ABCTX5035VG
	40 mm	500	ABCTX5040VG
	45 mm	500	ABCTX5045VG
	50 mm	500	ABCTX5050VG

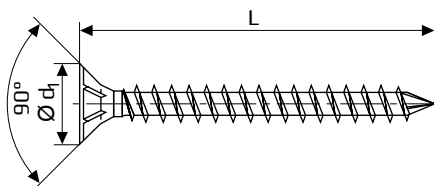

Universalschrauben

Vis universelle

Filet partiel, torx

Universalschraube

Teilgewinde, Torx



Info	Longueur	Qté/Emb	Code
	Länge	VPE	
ø 5 mm d1 = 9,7 mm T20	40 mm	500	ABCTX5040TG
	45 mm	500	ABCTX5045TG
	50 mm	500	ABCTX5050TG
	60 mm	500	ABCTX5060TG
		100	ABCTX5060TG1
	70 mm	200	ABCTX5070TG
		100	ABCTX5070TG1
	80 mm	200	ABCTX5080TG
		100	ABCTX5080TG1
	90 mm	200	ABCTX5090TG
		100	ABCTX5090TG1
	100 mm	200	ABCTX50100TG
	120 mm	200	ABCTX50120TG
	ø 6 mm d1 = 11,6 mm T30	40 mm	500
50 mm		200	ABCTX6050TG
60 mm		200	ABCTX6060TG
70 mm		200	ABCTX6070TG
80 mm		200	ABCTX6080TG
90 mm		200	ABCTX6090TG
100 mm		100	ABCTX60100TG
110 mm		100	ABCTX60110TG
120 mm		100	ABCTX60120TG
130 mm		100	ABCTX60130TG
140 mm		100	ABCTX60140TG
150 mm		100	ABCTX60150TG
160 mm		100	ABCTX60160TG
180 mm		100	ABCTX60180TG
200 mm	100	ABCTX60200TG	
220 mm	100	ABCTX60220TG	
240 mm	100	ABCTX60240TG	

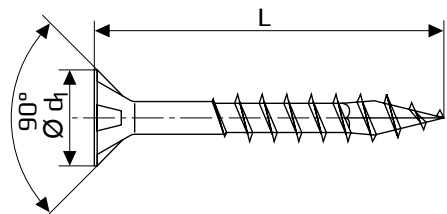
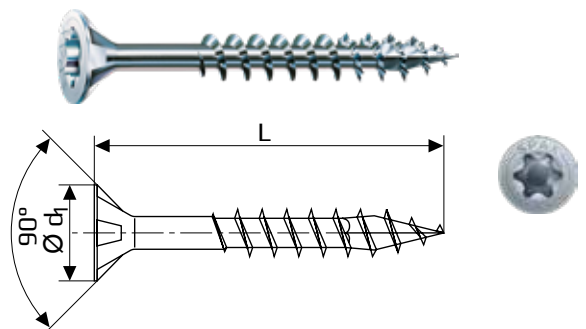

Vis universelle

Universalschrauben

Vis universelle

Filet total, torx

Universalschraube

Vollgewinde, Torx



Info	Longueur	Qté/Emb	Code
	Länge	VPE	
ø 3,0 mm d1 = 6 mm TX10	12 mm	1000	REIR2TX3012VG
	16 mm	1000	REIR2TX3016VG
	20 mm	1000	REIR2TX3020VG
	25 mm	1000	REIR2TX3025VG
	30 mm	1000	REIR2TX3030VG
	35 mm	1000	REIR2TX3035VG
	40 mm	1000	REIR2TX3040VG
ø 3,5 mm d1 = 7 mm TX20	12 mm	1000	REIR2TX3512VG
	16 mm	1000	REIR2TX3516VG
	20 mm	1000	REIR2TX3520VG
	25 mm	1000	REIR2TX3525VG
	30 mm	1000	REIR2TX3530VG
	35 mm	1000	REIR2TX3535VG
	40 mm	1000	REIR2TX3540VG
	45 mm	1000	REIR2TX3545VG
	50 mm	500	REIR2TX3550VG
ø 4 mm d1 = 8 mm TX20	16 mm	1000	REIR2TX4016VG
	20 mm	1000	REIR2TX4020VG
	25 mm	1000	REIR2TX4025VG
	30 mm	1000	REIR2TX4030VG
	35 mm	1000	REIR2TX4035VG
	40 mm	500	REIR2TX4040VG
	45 mm	500	REIR2TX4045VG
	50 mm	500	REIR2TX4050VG

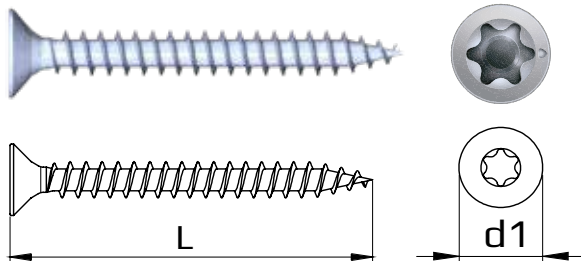

Vis universelle

Filet partiel, torx

Universalschraube

Teilgewinde, Torx



Info	Longueur	Qté/Emb	Code
	Länge	VPE	
ø 3,0 mm d1 = 6 mm TX10	35 mm	1000	REIR2TX3035TG
	40 mm	1000	REIR2TX3040TG
	45 mm	1000	REIR2TX3045TG
ø 3,5 mm d1 = 7 mm TX20	30 mm	1000	REIR2TX3530TG
	35 mm	1000	REIR2TX3535TG
	40 mm	1000	REIR2TX3540TG
	45 mm	1000	REIR2TX3545TG
	50 mm	500	REIR2TX3550TG
ø 4 mm d1 = 8 mm TX20	30 mm	1000	REIR2TX4030TG
	35 mm	1000	REIR2TX4035TG
	40 mm	500	REIR2TX4040TG
	45 mm	500	REIR2TX4045TG
	50 mm	500	REIR2TX4050TG
	60 mm	500	REIR2TX4060TG
	70 mm	200	REIR2TX4070TG

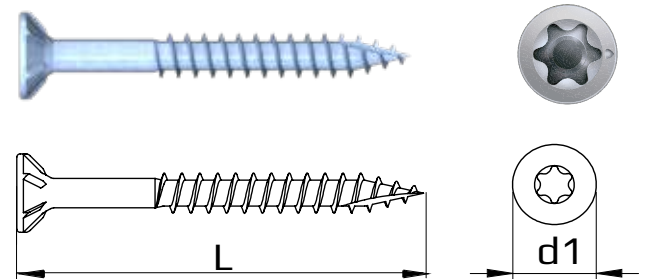

Vis universelle

Vis universelle

Filet total, torx

Universalschraube

Vollgewinde, Torx



Info	Longueur	Qté/Emb	Code
	Länge	VPE	
ø 4,5 mm d1 = 9 mm TX20	20 mm	1000	REIR2TX204520VG
	25 mm	1000	REIR2TX204525VG
	30 mm	1000	REIR2TX204530VG
	35 mm	1000	REIR2TX204535VG
	40 mm	500	REIR2TX204540VG
	45 mm	500	REIR2TX204545VG
	50 mm	500	REIR2TX204550VG
	60 mm	200	REIR2TX204560VG
ø 4,5 mm d1 = 9 mm TX25	20 mm	1000	REIR2TX254520VG
	25 mm	1000	REIR2TX254525VG
	30 mm	1000	REIR2TX254530VG
	35 mm	1000	REIR2TX254535VG
	40 mm	500	REIR2TX254540VG
	45 mm	500	REIR2TX254545VG
	50 mm	500	REIR2TX254550VG
	60 mm	200	REIR2TX254560VG
ø 5 mm d1 = 10 mm TX20	20 mm	1000	REIR2TX205020VG
	25 mm		REIR2TX205025VG
	30 mm		REIR2TX205030VG
	35 mm	500	REIR2TX205035VG
	40 mm		REIR2TX205040VG
	45 mm		REIR2TX205045VG
	50 mm		REIR2TX205050VG
	60 mm		REIR2TX205060VG
70 mm	200	REIR2TX205070VG	
80 mm		REIR2TX205080VG	

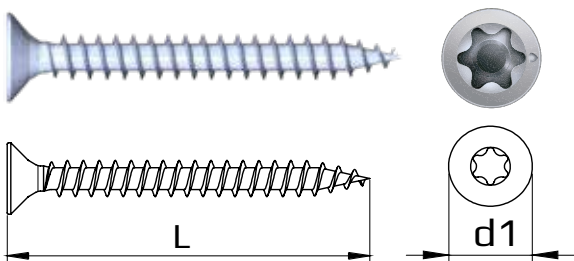

Universalschrauben

Vis universelle

Filet partiel, torx

Universalschraube

Teilgewinde, Torx



Info	Longueur	Qté/Emb	Code
	Länge	VPE	
ø 4,5 mm d1 = 9 mm TX20	40 mm	500	REIR2TX204540TG
	45 mm	500	REIR2TX204545TG
	50 mm	500	REIR2TX204550TG
	60 mm	200	REIR2TX204560TG
	70 mm	200	REIR2TX204570TG
	80 mm	200	REIR2TX204580TG
	ø 4,5 mm d1 = 9 mm TX25	40 mm	500
45 mm		500	REIR2TX254545TG
50 mm		500	REIR2TX254550TG
60 mm		200	REIR2TX254560TG
70 mm		200	REIR2TX254570TG
ø 5 mm d1 = 10 mm TX20	50 mm	200	REIR2TX205050TG
	60 mm	200	REIR2TX205060TG
	70 mm	200	REIR2TX205070TG
	80 mm	200	REIR2TX205080TG
	90 mm	200	REIR2TX205090TG
	100 mm	200	REIR2TX2050100TG
	120 mm	200	REIR2TX2050120TG
ø 5 mm d1 = 10 mm TX25	50 mm	200	REIR2TX255050TG
	60 mm	200	REIR2TX255060TG
	70 mm	200	REIR2TX255070TG
	80 mm	200	REIR2TX255080TG
	90 mm	200	REIR2TX255090TG
	100 mm	200	REIR2TX2550100TG
	120 mm	200	REIR2TX2550120TG

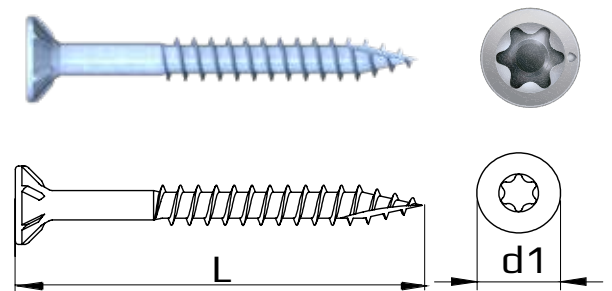

Vis universelle

Universalschrauben

Vis universelle

Filet total, torx

Universalschraube

Vollgewinde, Torx



Info	Longueur	Qté/Emb	Code
	Länge	VPE	
ø 5 mm d1 = 10 mm TX25	20 mm	1000	REIR2TX255020VG
	25 mm	1000	REIR2TX255025VG
	30 mm	1000	REIR2TX255030VG
	35 mm	500	REIR2TX255035VG
	40 mm	500	REIR2TX255040VG
	45 mm	500	REIR2TX255045VG
	50 mm	500	REIR2TX255050VG
	60 mm	200	REIR2TX255060VG
	70 mm	200	REIR2TX255070VG
	80 mm	200	REIR2TX255080VG
ø 6 mm d1 = 12 mm TX30	35 mm	200	REIR2TX6035VG
	40 mm	200	REIR2TX6040VG
	45 mm	200	REIR2TX6045VG
	50 mm	200	REIR2TX6050VG
	60 mm	200	REIR2TX6060VG
	70 mm	200	REIR2TX6070VG

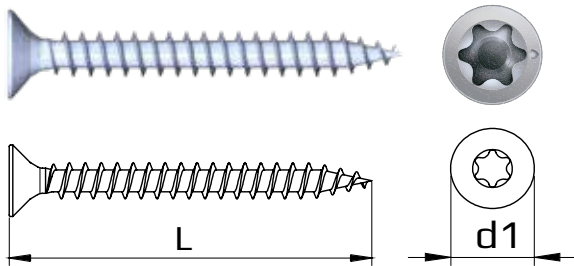

Vis universelle

Filet partiel, torx

Universalschraube

Teilgewinde, Torx



Info	Longueur	Qté/Emb	Code
	Länge	VPE	
ø 6 mm d1 = 12 mm TX30	60 mm	200	REIR2TX6060TG
	70 mm	200	REIR2TX6070TG
	90 mm	200	REIR2TX6090TG
	100 mm	200	REIR2TX60100TG
	110 mm	200	REIR2TX60110TG
	120 mm	200	REIR2TX60120TG
	130 mm	200	REIR2TX60130TG
	140 mm	200	REIR2TX60140TG
	150 mm	200	REIR2TX60150TG
	160 mm	200	REIR2TX60160TG
	180 mm	200	REIR2TX60180TG
	200 mm	200	REIR2TX60200TG
	220 mm	200	REIR2TX60220TG
	240 mm	200	REIR2TX60240TG
	260 mm	200	REIR2TX60260TG
	280 mm	200	REIR2TX60280TG
	300 mm	200	REIR2TX60300TG

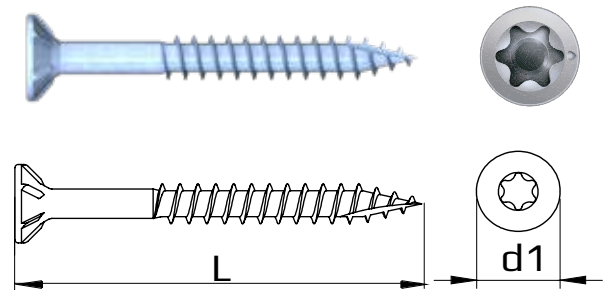

Vis universelle

Vis universelle

Filet total, PZ

Universalschraube

Vollgewinde, PZ



Info	Longueur	Qté/Emb	Code
	Länge	VPE	
ø 2,5 mm d1 = 5,1 mm PZ1	12 mm	1000	ABCP2512VG
	16 mm	1000	ABCP2516VG
ø 3 mm d1 = 6 mm PZ1	10 mm	1000	ABCP3010VG
	12 mm	1000	ABCP3012VG
	16 mm	1000	ABCP3016VG
	20 mm	1000	ABCP3020VG
	25 mm	1000	ABCP3025VG
	30 mm	1000	ABCP3030VG
	35 mm	1000	ABCP3035VG
	40 mm	1000	ABCP3040VG
ø 3,5 mm d1 = 7 mm PZ2	12 mm	1000	ABCP3512VG
	16 mm	1000	ABCP3516VG
	20 mm	1000	ABCP3520VG
	25 mm	1000	ABCP3525VG
	30 mm	1000	ABCP3530VG
	35 mm	1000	ABCP3535VG
	40 mm	1000	ABCP3540VG
	45 mm	1000	ABCP3545VG
ø 4 mm d1 = 8 mm PZ2	16 mm	1000	ABCP4016VG
	20 mm	1000	ABCP4020VG
	25 mm	1000	ABCP4025VG
	30 mm	1000	ABCP4030VG
	35 mm	1000	ABCP4035VG
	40 mm	1000	ABCP4040VG
	45 mm	500	ABCP4045VG
	70 mm	500	ABCP4070VG
ø 4,5 mm d1 = 8,8 mm PZ2	20 mm	1000	ABCP4520VG
	25 mm	1000	ABCP4525VG
	30 mm	1000	ABCP4530VG
	35 mm	1000	ABCP4535VG
	40 mm	500	ABCP4540VG
	45 mm	500	ABCP4545VG
ø 5 mm d1 = 9,7 mm PZ2	25 mm	1000	ABCP5025VG
	30 mm	500	ABCP5030VG
	35 mm	500	ABCP5035VG
	40 mm	500	ABCP5040VG
	45 mm	500	ABCP5045VG
ø 6 mm d1 = 11,6 mm PZ3	40 mm	500	ABCP6040VG



Universalschrauben

Vis universelle

Filet partiel, PZ

Universalschraube

Teilgewinde, PZ



Info	Longueur	Qté/Emb	Code
	Länge	VPE	
ø 3,5 mm d1 = 7 mm PZ 2	50 mm	500	ABCP3550TG
ø 4 mm d1 = 8 mm PZ2	50 mm	500	ABCP4050TG
	55 mm	500	ABCP4055TG
	60 mm	500	ABCP4060TG
ø 4,5 mm d1 = 8,8 mm PZ2	50 mm	500	ABCP4550TG
	60 mm	500	ABCP4560TG
	70 mm	500	ABCP4570TG
ø 5 mm d1 = 9,7 mm PZ2	50 mm	500	ABCP5050TG
	60 mm	500	ABCP5060TG
	70 mm	500	ABCP5070TG
	80 mm	500	ABCP5080TG
	90 mm	200	ABCP5090TG
	100 mm	200	ABCP50100TG
	120 mm	200	ABCP50120TG
ø 6 mm d1 = 11,6 mm PZ3	60 mm	200	ABCP6060TG
	70 mm	200	ABCP6070TG
	80 mm	200	ABCP6080TG
	90 mm	200	ABCP6090TG
	100 mm	100	ABCP60100TG
	120 mm	100	ABCP60120TG
	140 mm	100	ABCP60140TG
	160 mm	100	ABCP60160TG

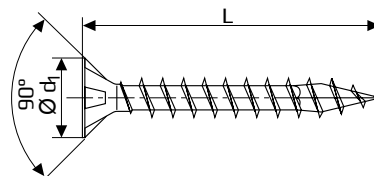
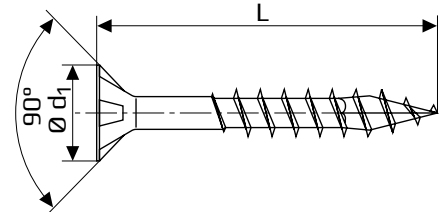

Vis universelle

Universalschrauben

Vis universelle

Filet total, PZ

Universalschraube

Vollgewinde, PZ



Info	Longueur	Qté/Emb	Code
	Länge	VPE	
ø 2,5 mm d1 = 5 mm PZD1	20 mm	200	REIR2PZ2520VG
	25 mm	200	REIR2PZ2525VG
ø 3,5 mm d1 = 7 mm PZD2	16 mm	200	REIR2PZ3516VG
	20 mm	200	REIR2PZ3520VG
	25 mm	200	REIR2PZ3525VG
	30 mm	200	REIR2PZ3530VG
	35 mm	200	REIR2PZ3535VG
	40 mm	200	REIR2PZ3540VG
	45 mm	200	REIR2PZ3545VG
	50 mm	200	REIR2PZ3550VG
ø 4 mm d1 = 8 mm PZD2	30 mm	200	REIR2PZ4030VG
	35 mm	200	REIR2PZ4035VG
	40 mm	200	REIR2PZ4040VG
	45 mm	200	REIR2PZ4045VG
	50 mm	200	REIR2PZ4050VG
ø 4,5 mm d1 = 9 mm PZD2	30 mm	200	REIR2PZ4530VG
	35 mm	200	REIR2PZ4535VG
	40 mm	200	REIR2PZ4540VG
	45 mm	200	REIR2PZ4545VG
	50 mm	200	REIR2PZ4550VG
	60 mm	200	REIR2PZ4560VG
ø 5 mm d1 = 10 mm PZD2	30 mm	200	REIR2PZ5030VG
	35 mm	200	REIR2PZ5035VG
	40 mm	200	REIR2PZ5040VG
	45 mm	200	REIR2PZ5045VG
	50 mm	200	REIR2PZ5050VG
	60 mm	200	REIR2PZ5060VG
	70 mm	200	REIR2PZ5070VG
	80 mm	200	REIR2PZ5080VG

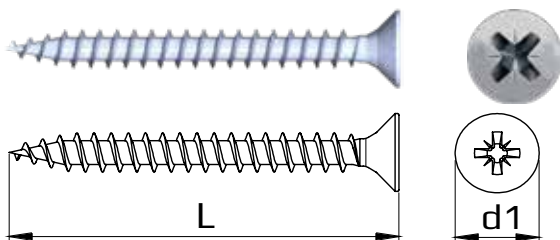

Vis universelle

Filet partiel, PZ

Universalschraube

Teilgewinde, PZ



Info	Longueur	Qté/Emb	Code
	Länge	VPE	
ø 4 mm d1 = 8 mm PZD2	40 mm	200	REIR2PZ4040TG
	45 mm	200	REIR2PZ4045TG
	50 mm	200	REIR2PZ4050TG
	60 mm	200	REIR2PZ4060TG
	70 mm	200	REIR2PZ4070TG
ø 4,5 mm d1 = 9 mm PZD2	60 mm	200	REIR2PZ4560TG
	70 mm	200	REIR2PZ4570TG
	80 mm	200	REIR2PZ4580TG
ø 5 mm d1 = 10 mm PZD2	50 mm	200	REIR2PZ5050TG
	60 mm	200	REIR2PZ5060TG
	70 mm	200	REIR2PZ5070TG
	80 mm	200	REIR2PZ5080TG
	90 mm	200	REIR2PZ5090TG
	100 mm	200	REIR2PZ50100TG
	120 mm	200	REIR2PZ50120TG

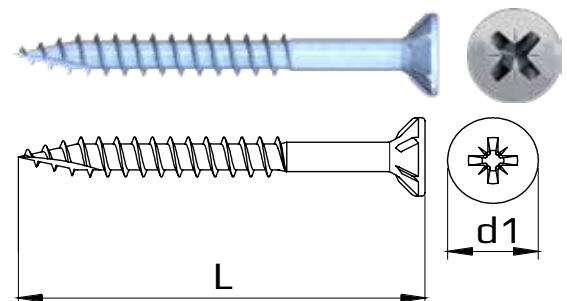

Vis universelle Inox A2

Vis universelle

Filet total, torx

Universalschraube

Vollgewinde, Torx



Info	Longueur	Qté/Emb	Code
	Länge	VPE	
ø 3,5 mm d1 = 7 mm TX10	16 mm	200	RETI2PTX3516VG
	20 mm	200	RETI2PTX3520VG
	25 mm	200	RETI2PTX3525VG
	30 mm	200	RETI2PTX3530VG
	35 mm	200	RETI2PTX3535VG
	40 mm	200	RETI2PTX3540VG
ø 4 mm d1 = 8 mm TX20	20 mm	200	RETI2PTX4020VG
	25 mm	200	RETI2PTX4025VG
	30 mm	200	RETI2PTX4030VG
	35 mm	200	RETI2PTX4035VG
	40 mm	200	RETI2PTX4040VG
	45 mm	200	RETI2PTX4045VG
	50 mm	200	RETI2PTX4050VG
ø 4,5 mm d1 = 9 mm TX20	25 mm	200	RETI2PTX4525VG
	30 mm	200	RETI2PTX4530VG
	35 mm	200	RETI2PTX4535VG
	40 mm	200	RETI2PTX4540VG
	50 mm	200	RETI2PTX4550VG
ø 5 mm d1 = 10 mm TX25	25 mm	200	RETI2PTX5025VG
	30 mm	200	RETI2PTX5030VG
	35 mm	200	RETI2PTX5035VG
	40 mm	200	RETI2PTX5040VG
	45 mm	200	RETI2PTX5045VG
	50 mm	200	RETI2PTX5050VG
	60 mm	200	RETI2PTX5060VG
ø 6 mm d1 = 12 mm TX25	40 mm	200	RETI2PTX6040VG
	50 mm	200	RETI2PTX6050VG
	60 mm	200	RETI2PTX6060VG



Universalschrauben Edelstahl A2

Vis universelle

Filet partiel, torx

Universalschraube

Teilgewinde, Torx



Info	Longueur	Qté/Emb	Code
	Länge	VPE	
ø 3,5 mm d1 = 7 mm TX10	30 mm	200	RETI2PTX3530TG
	35 mm	200	RETI2PTX3535TG
	40 mm	200	RETI2PTX3540TG
ø 4 mm d1 = 8 mm TX20	30 mm	200	RETI2PTX4030TG
	35 mm	200	RETI2PTX4035TG
	40 mm	200	RETI2PTX4040TG
	45 mm	200	RETI2PTX4045TG
	50 mm	200	RETI2PTX4050TG
ø 4,5 mm d1 = 9 mm TX20	60 mm	200	RETI2PTX4060TG
	70 mm	200	RETI2PTX4070TG
	35 mm	200	RETI2PTX4535TG
	40 mm	200	RETI2PTX4540TG
	45 mm	200	RETI2PTX4545TG
	50 mm	200	RETI2PTX4550TG
	60 mm	200	RETI2PTX4560TG
ø 5 mm d1 = 10 mm TX25	70 mm	200	RETI2PTX4570TG
	80 mm	200	RETI2PTX4580TG
	40 mm	200	RETI2PTX5040TG
	45 mm	200	RETI2PTX5045TG
	50 mm	200	RETI2PTX5050TG
	60 mm	200	RETI2PTX5060TG
	70 mm	200	RETI2PTX5070TG
	80 mm	200	RETI2PTX5080TG
ø 6 mm d1 = 12 mm TX25	90 mm	200	RETI2PTX5090TG
	100 mm	200	RETI2PTX50100TG
	120 mm	200	RETI2PTX50120TG
	60 mm	100	RETI2PTX6060TG
	70 mm	100	RETI2PTX6070TG
	80 mm	100	RETI2PTX6080TG
	90 mm	100	RETI2PTX6090TG
	100 mm	100	RETI2PTX60100TG
	120 mm	100	RETI2PTX60120TG
	130 mm	100	RETI2PTX60130TG
ø 6 mm d1 = 12 mm TX25	140 mm	100	RETI2PTX60140TG
	150 mm	100	RETI2PTX60150TG
	160 mm	100	RETI2PTX60160TG



Vis universelle Inox A2

Vis universelle

Filet total, torx

Universalschraube

Vollgewinde, Torx

Info	Longueur	Qté/Emb	Code
	Länge	VPE	
ø 3 mm d1 = 6 mm TX10	30 mm	500	SP914723030
	40 mm	200	SP914723040
	50 mm	200	SP914723050
ø 3,5 mm d1 = 7 mm TX10	20 mm	500	SP914723520
	25 mm	500	SP914723525
	30 mm	500	SP914723530
	35 mm	500	SP914723535
	40 mm	200	SP914723540
	45 mm	200	SP914723545
	50 mm	200	SP914723550
ø 4 mm d1 = 8 mm TX20	20 mm	500	SP914724020
	25 mm	500	SP914724025
	30 mm	500	SP914724030
	35 mm	500	SP914724035
	40 mm	200	SP914724040
	45 mm	200	SP914724045
	50 mm	200	SP914724050
	60 mm	200	SP914724060
ø 4,5 mm d1 = 9 mm TX20	20 mm	500	SP914724520
	25 mm	500	SP914724525
	30 mm	500	SP914724530
	35 mm	500	SP914724535
	40 mm	200	SP914724540
	45 mm	200	SP914724545
	50 mm	200	SP914724550
	60 mm	200	SP914724560
	70 mm	200	SP914724570
	80 mm	200	SP914724580



Universalschrauben Edelstahl A2

Vis universelle

Filet partiel, torx

Universalschraube

Teilgewinde, Torx

Info	Longueur	Qté/Emb	Code
	Länge	VPE	
ø 5 mm d1 = 10 mm TX25	20 mm	500	SP914725020
	25 mm	500	SP914725025
	30 mm	500	SP914725030
	35 mm	500	SP914725035
	40 mm	200	SP914725040
	45 mm	200	SP914725045
	50 mm	200	SP914725050
	60 mm	100	SP914725060
	70 mm	100	SP914725070
	80 mm	100	SP914725080
	90 mm	100	SP914725090
	120 mm	100	SP9147250120
ø 6 mm d1 = 12 mm TX25	30 mm	100	SP914726030
	40 mm	100	SP914726040
	45 mm	100	SP914726045
	50 mm	100	SP914726050
	60 mm	100	SP914726060
	70 mm	100	SP914726070
	80 mm	100	SP914726080
	90 mm	100	SP914726090
100 mm	100	SP9147260100	
120 mm	100	SP9147260120	

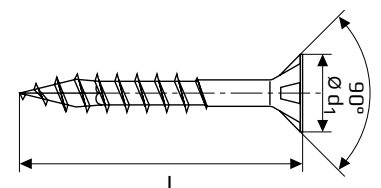

Vis universelle Inox A2

Vis universelle

Filet total, torx

Universalschraube

Vollgewinde, Torx



Info	Longueur	Qté/Emb	Code
	Länge	VPE	
ø 3 mm d1 = 6 mm T10	12 mm	200	ABCA23012VG
	16 mm	200	ABCA23016VG
	20 mm	200	ABCA23020VG
	25 mm	200	ABCA23025VG
	30 mm	200	ABCA23030VG
	35 mm	200	ABCA23035VG
	40 mm	200	ABCA23040VG
ø 3,5 mm d1 = 7 mm T15	16 mm	200	ABCA23516VG
	20 mm	200	ABCA23520VG
	25 mm	200	ABCA23525VG
	30 mm	200	ABCA23530VG
	35 mm	200	ABCA23535VG
	40 mm	200	ABCA23540VG
ø 4 mm d1 = 8 mm T20	20 mm	200	ABCA24020VG
	25 mm	200	ABCA24025VG
	30 mm	200	ABCA24030VG
	35 mm	200	ABCA24035VG
	40 mm	200	ABCA24040VG
	45 mm	200	ABCA24045VG
	50 mm	200	ABCA24050VG
	60 mm	100	ABCA24060VG

Universalschrauben Edelstahl A2

Vis universelle

Filet partiel, torx

Universalschraube

Teilgewinde, Torx



Info	Longueur	Qté/Emb	Code
	Länge	VPE	
ø 3,5 mm d1 = 7 mm T15	30 mm	200	ABCA23530TG
	35 mm	200	ABCA23535TG
	40 mm	200	ABCA23540TG
ø 4 mm d1 = 8 mm T20	30 mm	200	ABCA24030TG
	35 mm	200	ABCA24035TG
	40 mm	200	ABCA24040TG
	45 mm	200	ABCA24045TG
	50 mm	200	ABCA24050TG
ø 4,5 mm d1 = 8,8 mm T20	40 mm	200	ABCA24540TG
	45 mm	200	ABCA24545TG
	50 mm	200	ABCA24550TG
	60 mm	200	ABCA24560TG
	70 mm	200	ABCA24570TG
	ø 5 mm d1 = 9,7 mm T20	40 mm	200
45 mm		200	ABCA25045TG
50 mm		200	ABCA25050TG
60 mm		100	ABCA25060TG
70 mm		100	ABCA25070TG
80 mm		100	ABCA25080TG
90 mm		100	ABCA25090TG
100 mm		100	ABCA250100TG
120 mm		100	ABCA250120TG

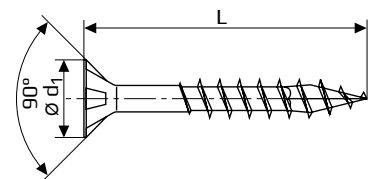
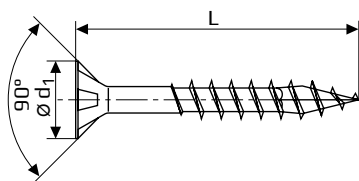

Vis universelle Inox A2

Vis universelles

Lieseko, torx

Universalschrauben

Linsensenkopf, Torx

Info	Longueur	Qté/Emb	Code
	Länge	VPE	
ø 4 mm d1 = 8 mm TX20	25 mm	500	SP90464025
	30 mm	500	SP90464030
	35 mm	500	SP90464035
	40 mm	200	SP90464040
	45 mm	200	SP90464045
	50 mm	200	SP90464050
ø 4,5 mm d1 = 9 mm TX20	40 mm	200	SP90464540
	45 mm	200	SP90464545
	50 mm	200	SP90464550
	60 mm	200	SP90464560
	70 mm	200	SP90464570

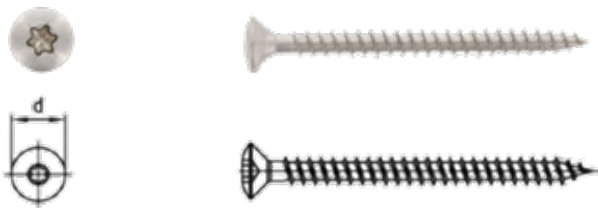

Universalschrauben Edelstahl A2

Vis universelle

Tête ronde renforcée, torx

Universalschraube

Verstärkter Rundkopf, Torx

Info	Longueur	Qté/Emb	Code
	Länge	VPE	
ø 4 mm d1 = 8 mm TX20	16 mm	500	SP90454016
	20 mm	500	SP90454020
	25 mm	500	SP90454025
	30 mm	500	SP90454030
	35 mm	500	SP90454035
	40 mm	200	SP90454040
	45 mm	200	SP90454045
	50 mm	200	SP90454050
ø 4,5 mm d1 = 9 mm TX20	30 mm	500	SP90454530
	35 mm	500	SP90454535
	40 mm	200	SP90454540
	45 mm	200	SP90454545
	50 mm	200	SP90454550
	60 mm	200	SP90454560
	70 mm	200	SP90454570



Vis façade

Vis façade

Inox A4

Fassadenschrauben

Edelstahl A4



Info	Longueur	Qté/Emb	Code
	Länge	VPE	
3,2 mm d1 = 5,10 mm IVT5050 T10	35 mm	1000	901480
	40 mm	1000	901481
	50 mm	1000	903104

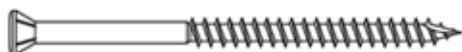

Vis façade Sparibo, inox

Inox A2

Fassadenschrauben Sparibo, Edelstahl

Edelstahl A2



Info	Longueur	Qté/Emb	Code
	Länge	VPE	
ø 3,2 mm d1 = 5,2 mm TX10	40 mm	1000	REIVF3240TG
	50 mm	1000	REIVF3250TG
	60 mm	1000	REIVF3260TG



Fassadeschrauben

Vis façade

Inox A2

Fassadenschrauben

Edelstahl A2

Info	Longueur	Qté/Emb	Code
	Länge	VPE	
3,2 mm d1 = 5,25 mm TX10	40 mm	200	SP90412324024
	50 mm	200	SP90412325030
	60 mm	200	SP90412326035

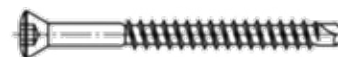
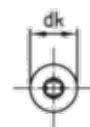

Vis bardage, inox

Petite tête A2

Fassadenschrauben, Edelstahl

Sehr kleiner Kopf A2



Info	Longueur	Qté/Emb	Code
	Länge	VPE	
ø 4 mm d1 = 6 mm TX15	40 mm	100	ABCFA4040
	45 mm	100	ABCFA4045
ø 4,5 mm d1 = 7 mm TX15	70 mm	100	ABCFA4070

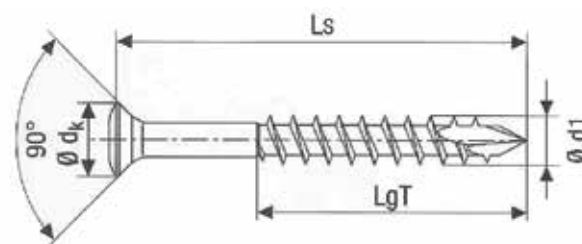

Vis terrasses

Terrassenschrauben

Vis terrasse structure bois

Inox A2, torx

Terrassenschrauben für Holzunterkonstruktion

Edelstahl A2, Torx



Info	Longueur	Qté/Emb	Code
	Länge	VPE	
ø 5 mm d1 = 6,8 mm TX20	50 mm	200	REIVT5050
	60 mm	180	REIVT5060
	70 mm	150	REIVT5070
	80 mm	150	REIVT5080

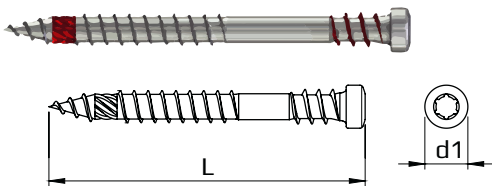

Vis terrasse structure bois

Inox A2, torx, couleur antique

Terrassenschrauben für Holzunterkonstruktion

Edelstahl A2, Torx, Antikfarben



Info	Longueur	Qté/Emb	Code
	Länge	VPE	
ø 5 mm d1 = 6,8 mm TX20	50 mm	200	REIVT5050ANT
	60 mm	180	REIVT5060ANT
	70 mm	150	REIVT5070ANT
	80 mm	150	REIVT5080ANT

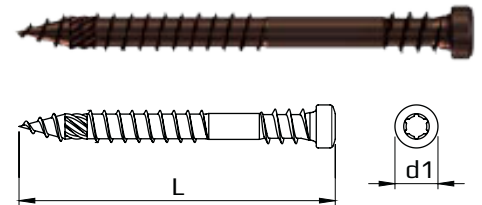

Vis terrasse structure alu

Filet total, torx

Terrassenschrauben für Aluminium Unterkonstruktion

Vollgewinde, Torx



Info	Longueur	Qté/Emb	Code
	Länge	VPE	
ø 5,5 mm d1 = 12 mm T20	65 mm	Argenté Silberfarben	REI061346
	75 mm		REI061360
	65 mm	Marron Kastanienbraun	REI061605
	75 mm		REI061629



Vis terrasse structure bois

Inox A2

Terrassenschrauben für Holzunterkonstruktion

Edelstahl A2



Info	Longueur	Qté/Emb	Code
	Länge	VPE	
ø 5 mm d1 = 7 mm TX25	40 mm	200	ABCD5040INOX
	50 mm	200	ABCD5050INOX
	60 mm	100	ABCD5060INOX
	70 mm	100	ABCD5070INOX
	80 mm	100	ABCD5080INOX



Vis

Schrauben

Eurovis

Tête fraisée PZ acier nickelé brillant

EURO schrauben

Zenkopf PZ Stahl



Info	Longueur	Qté/Emb	Code
	Länge	VPE	
ø 6,3 mm d1 = 7,7 mm	10 mm	100	REIEURO10
	11 mm	100	REIEURO11
	12 mm	100	REIEURO12
	13 mm	100	REIEURO13
	14 mm	100	REIEURO14
	15 mm	100	REIEURO15
	16 mm	100	REIEURO16

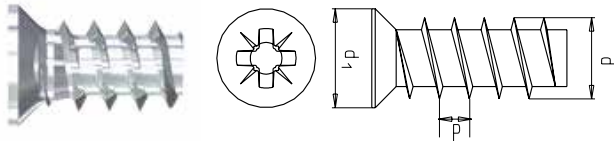

Vis pour parquet massif

Filet partiel, torx

Schraube für massiv Böden

Teilgewinde, Torx



Info	Longueur	Qté/Emb	Code
	Länge	VPE	
ø 3,5 mm d1 = 6 mm TX10	45 mm	500	ABCS3545

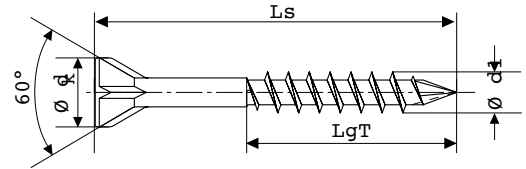

Vis pour MDF

Filet partiel, torx

MDF - Schrauben

Teilgewinde, Torx



Info	Longueur	Qté/Emb	Code
	Länge	VPE	
ø 3,5 mm d1 = 6 mm T15	40 mm	200	ABCM3540
	45 mm	200	ABCM3545
	50 mm	200	ABCM3550
ø 4,0 mm d1 = 7 mm T20	40 mm	200	ABCM4040
	45 mm	200	ABCM4045
	50 mm	200	ABCM4050
	60 mm	100	ABCM4060
ø 4,5 mm d1 = 8 mm T20	45 mm	200	ABCM4545
	50 mm	200	ABCM4550

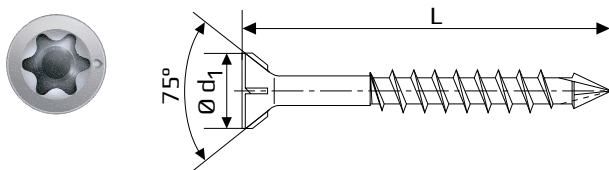

Vis assemblage meuble

Filet partiel, torx

Möbel-Montageschraube

Teilgewinde, Torx



Info	Longueur	Qté/Emb	Code
	Länge	VPE	
ø 45 mm d1 = 10 mm TX20	30 mm	1000	REIVP4030TG
	35 mm	500	REIVP4035TG



Vis à bouchons & vis MDF

Vis universelle à bouchon

Filet total, torx

Universalschrauben m. Kopflochbohrung

Vollgewinde, Torx, Bohrung für Abdeckkappen



Info	Longueur	Qté/Emb	Code
	Länge	VPE	
ø 4,5 mm d1 = 8,8 mm PZ2	25 mm	1000	ABCI4525
	30 mm	1000	ABCI4530
	35 mm	500	ABCI4535
	40 mm	500	ABCI4540
	45 mm	500	ABCI4545
	50 mm	500	ABCI4550
	55 mm	500	ABCI4555
	60 mm	500	ABCI4560

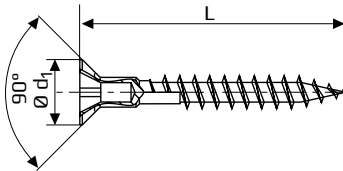
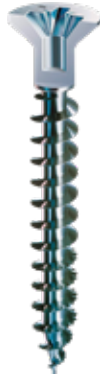

Vis à bois R2 avec trou intérieur

Tête fraisée PZ acier, zingué bleu/blanc

Holzschrauben R2 Innenloch PZD

Zenkkopf, Stahl, verzinkt blau/weiss



Info	Longueur	Qté/Emb	Code
	Länge	VPE	
ø 4,5 mm d1 = 8,5 mm PZ2	25 mm	100	REIR2TI4525VG
	30 mm	100	REIR2TI4530VG
	35 mm	100	REIR2TI4535VG
	40 mm	100	REIR2TI4540VG
	45 mm	100	REIR2TI4545VG
	50 mm	100	REIR2TI4550VG
	50 mm	50	REIR2TI4550VG1
	60 mm	100	REIR2TI4560VG
	70 mm	100	REIR2TI4570VG
	80 mm	100	REIR2TI4580VG

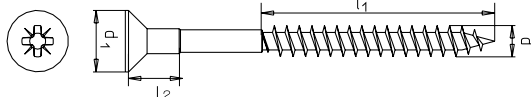

Schrauben mit Kopflochbohrung & MDF Schrauben

Bouchons

pour vis universelles à bouchon

Abdeckkappen

Für Universalschrauben mit Kopflochbohrung



Couleur	Qté/Emb	Code
Farbe	VPE	
Acajou Akazie	500	ABCCAPACAJOU
Beige Beige	500	ABCCAPBEIGE
Blanc Weiß	500	ABCCAPBLANC
Gris Grau	500	ABCCAPGRIS
Marron clair Rehbraun	500	ABCCAPMACL
Noir Schwarz	500	ABCCAPNOIR
Ocre Ockergelb	500	ABCCAPOCRE

Bouchons

pour vis universelles à bouchon

Abdeckkappen

Für Universalschrauben mit Kopflochbohrung



Couleur	Qté/Emb	Code
Farbe	VPE	
RAL 7035	200	REI008440
RAL 8001	200	REI005074
RAL 8007	200	REI310178
RAL 8011	200	REI310161
RAL 9010	200	REI008433

Vis d'assemblage & de réglage & à panneaux

Vis de réglage bois-bois RN 0197

TX , zingué blanc

Holz-Holz-Stellschraube RN 0197

Senkkopf TX-Stahl, weiß verzinkt



Info	Longueur	Qté/Emb	Code
	Länge	VPE	
\varnothing 6 mm d1 = 10 mm T25	50 mm	100	REI013451
	70 mm	100	REI013468
	80 mm	100	REI013475
	90 mm	100	REI013482
	100 mm	50	REI013499
	110 mm	50	REI013505
	120 mm	50	REI013512
	130 mm	50	REI013529
	145 mm	50	REI013536
160 mm	50	REI013543	

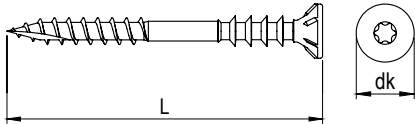

Vis de réglage bois-béton RN 0198

TX , zingué blanc

Holz-Beton-Stellschraube RN 0198

Senkkopf TX-Stahl, weiß verzinkt



Info	Longueur	Qté/Emb	Code
	Länge	VPE	
\varnothing 6 mm d1 = 12 mm TX30	70 mm	100	REI032230
	80 mm	100	REI032247
	90 mm	100	REI032254
	100 mm	100	REI061766
	110 mm	100	REI061773
	120 mm	50	REI061797
	130 mm	50	REI061810



Verbindungs- & Justiers- & Plattenschrauben

Vis à panneaux Dribo

Filet partiel, torx

Dribo - Plattenschraube

Teilgewinde, Torx



Info	Longueur	Qté/Emb	Code
	Länge	VPE	
\varnothing 3,5 mm d1 = 7 mm T15	30 mm	750	DRI3530VG
\varnothing 4,0 mm d1 = 8 mm T20	30 mm	650	DRI4030TG
	35 mm	580	DRI4035TG
	40 mm	510	DRI4040TG
	45 mm	450	DRI4045TG
	50 mm	410	DRI4050TG
\varnothing 4,5 mm d1 = 9 mm T20	60 mm	230	DRI4060TG
	40 mm	430	DRI4540TG
	45 mm	340	DRI4545TG
	50 mm	320	DRI4550TG
\varnothing 5,0 mm d1 = 10 mm T25	60 mm	250	DRI4560TG
	70 mm	140	DRI4570TG
	50 mm	260	DRI5050TG
	60 mm	220	DRI5060TG
\varnothing 5,0 mm d1 = 10 mm T25	70 mm	160	DRI5070TG
	80 mm	150	DRI5080TG
	100 mm	140	DRI50100TG
	\varnothing 6,0 mm d1 = 12 mm T25	60 mm	160
80 mm		110	DRI6080TG
100 mm		100	DRI60100TG
120 mm		90	DRI60120TG
140 mm		80	DRI60140TG
150 mm		60	DRI60150TG

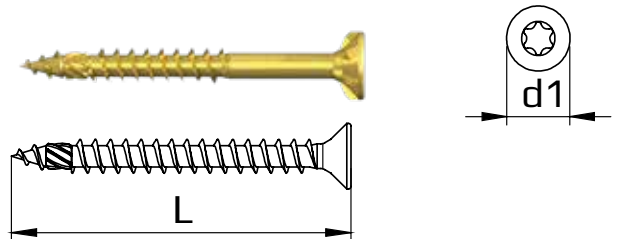

Vis de construction

Vis de construction
Filet partiel avec tête plate

Konstruktionsschrauben
Teilgewinde mit Tellerkopf



Info	Longueur	Qté/Emb	Code
	Länge	VPE	
ø 6 mm d1 = 14 mm TX30	40 mm	100	REITKS16040
	60 mm	100	REITKS16060
	80 mm	50	REITKS16080
	100 mm	50	REITKS160100
	120 mm	50	REITKS160120
	140 mm	50	REITKS160140
	160 mm	50	REITKS160160
	180 mm	50	REITKS160180
	200 mm	50	REITKS160200
	220 mm	50	REITKS160220
	240 mm	50	REITKS160240
	260 mm	50	REITKS160260
	280 mm	50	REITKS160280
	300 mm	50	REITKS160300
ø 8 mm d1 = 22 mm TX40	80 mm	25	REITKS18080
	100 mm	25	REITKS180100
	120 mm	25	REITKS180120
	140 mm	25	REITKS180140
	160 mm	25	REITKS180160
	180 mm	25	REITKS180180
	200 mm	25	REITKS180200
	220 mm	25	REITKS180220
	240 mm	25	REITKS180240
	260 mm	25	REITKS180260
	280 mm	25	REITKS180280
	300 mm	25	REITKS180300
	320 mm	25	REITKS180320
	340 mm	25	REITKS180340
360 mm	25	REITKS180360	

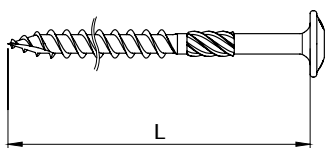

Holzbau- & Tellerkopfschrauben

Vis de construction avec tête plate
Filet partiel

Konstruktionsschraube mit Tellerkopf
Teilgewinde



Info	Longueur	Qté/Emb	Code
	Länge	VPE	
ø 10 mm d1 = 25 mm TX40	100 mm	25	REITKS110100
	120 mm	25	REITKS110120
	140 mm	25	REITKS110140
	160 mm	25	REITKS110160
	180 mm	25	REITKS110180
	200 mm	25	REITKS110200
	220 mm	25	REITKS110220
	240 mm	25	REITKS110240
	260 mm	25	REITKS110260
	280 mm	25	REITKS110280
	300 mm	25	REITKS110300
	320 mm	25	REITKS110320
	340 mm	25	REITKS110340
	360 mm	25	REITKS110360
	380 mm	25	REITKS110380
	400 mm	25	REITKS110400
	450 mm	25	REITKS110450
	500 mm	25	REITKS110500

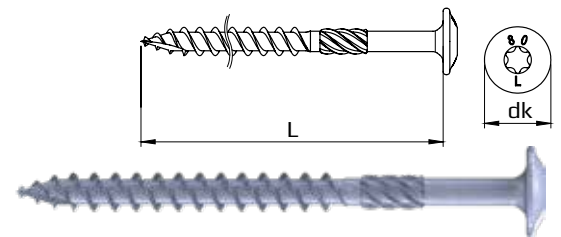

Vis de construction

Vis de construction

Tête fraisée

Konstruktionsschrauben

Mit Senkkopf



Info	Longueur	Qté/Emb	Code
	Länge	VPE	
ø 8 mm d1 = 15mm TX40	80 mm	75	GPRTF880
	100 mm	75	GPRTF8100
	120 mm	75	GPRTF8120
	140 mm	75	GPRTF8140
	160 mm	75	GPRTF8160
	180 mm	75	GPRTF8180
	200 mm	75	GPRTF8200
	220 mm	75	GPRTF8220
	240 mm	75	GPRTF8240
	260 mm	75	GPRTF8260
	280 mm	75	GPRTF8280
	300 mm	75	GPRTF8300

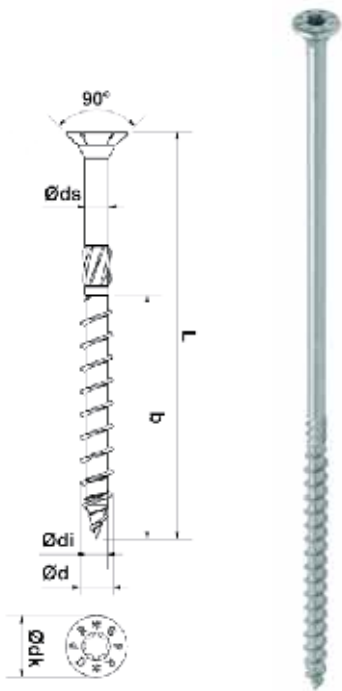

Holzbau- & Tellerkopfschrauben

Vis de construction

Tête plate

Konstruktionsschrauben

Tellerkopf



Info	Longueur	Qté/Emb	Code
	Länge	VPE	
ø 6 mm d1 = 14mm TX30	60 mm	100	GP RTP660
	80 mm	100	GP RTP680
	100 mm	100	GP RTP6100
	120 mm	100	GP RTP6120
	140 mm	100	GP RTP6140
	160 mm	50	GP RTP6160
	180 mm	50	GP RTP6180
	200 mm	50	GP RTP6200
ø 8 mm d1 = 20mm TX40	80 mm	50	GP RTP880
	100 mm	50	GP RTP8100
	120 mm	50	GP RTP8120
	140 mm	50	GP RTP8140
	160 mm	50	GP RTP8160
	180 mm	50	GP RTP8180
	200 mm	50	GP RTP8200
	220 mm	50	GP RTP8220
	240 mm	50	GP RTP8240
	260 mm	50	GP RTP8260
	280 mm	50	GP RTP8280
	300 mm	50	GP RTP8300
	320 mm	50	GP RTP8320
	340 mm	50	GP RTP8340
360 mm	50	GP RTP8360	
380 mm	50	GP RTP8380	
400 mm	50	GP RTP8400	

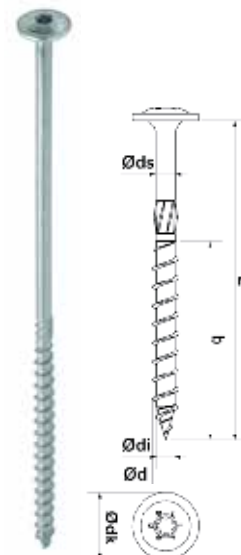

Vis de construction

Holzbau- & Tellerkopfschrauben

Tire-fonds

Tête hexagonale, zingué bleu

Sechskant-Holzschraube

Sechskant-Kopf, Stahl blauerzinkt



Info	Longueur	Qté/Emb	Code
	Länge	VPE	
ø 6 mm S = 10	30 mm	200	REI571H0630
	35 mm	200	REI571H0635
	40 mm	200	REI571H0640
	45 mm	200	REI571H0645
	50 mm	200	REI571H0650
	60 mm	200	REI571H0660
	70 mm	200	REI571H0670
	80 mm	200	REI571H0680
	90 mm	100	REI571H0690
ø 8 mm S = 12 TX40	60 mm	50	REIHBS18060
	80 mm	50	REIHBS18080
	100 mm	50	REIHBS180100
	120 mm	50	REIHBS180120
	140 mm	50	REIHBS180140
	160 mm	50	REIHBS180160
	180 mm	50	REIHBS180180
	200 mm	50	REIHBS180200
ø 10 mm S = 15 TX40	80 mm	50	REIHBS11080
	100 mm	50	REIHBS110100
	120 mm	50	REIHBS110120
	140 mm	50	REIHBS110140
	160 mm	50	REIHBS110160
	180 mm	50	REIHBS110180
	200 mm	50	REIHBS110200
ø 12 mm S = 17 TX40	100 mm	25	REIHBS112100
	120 mm	25	REIHBS112120
	140 mm	25	REIHBS112140
	160 mm	25	REIHBS112160
	180 mm	25	REIHBS112180
	200 mm	25	REIHBS112200

Tire-fonds inox

Tête hexagonale

Sechskant-Holzschraube Edelstahl

Sechskant-Kopf

Info	Longueur	Qté/Emb	Code
	Länge	VPE	
ø 6 mm S = 10	30 mm	200	SP571630
	35 mm	200	SP571635
	40 mm	200	SP571640
	50 mm	200	SP571650
	60 mm	200	SP571660
	ø 8 mm S = 13	30 mm	100
35 mm		100	SP571835
40 mm		100	SP571840
50 mm		100	SP571850
60 mm		100	SP571860
70 mm		100	SP571870
80 mm		100	SP571880
90 mm		100	SP571890
ø 10 mm S = 17	40 mm	100	SP5711040
	50 mm	100	SP5711050
	60 mm	100	SP5711060
	70 mm	100	SP5711070
	80 mm	100	SP5711080
	90 mm	50	SP5711090
	100 mm	50	SP5711100
	120 mm	50	SP5711120
	130 mm	50	SP5711130
	140 mm	50	SP5711140
	150 mm	50	SP5711150
	160 mm	50	SP5711160
	200 mm	50	SP5711200

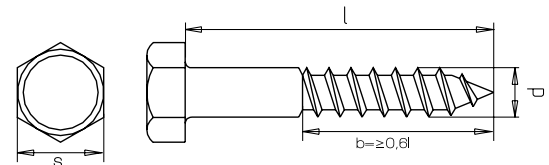
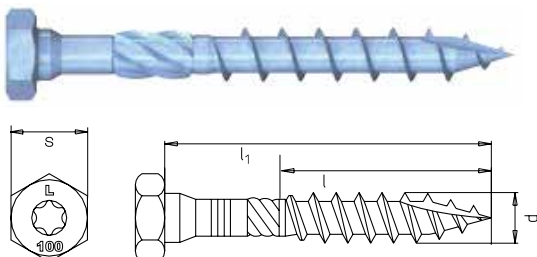

Vis châssis de fenêtre

Vis châssis avec tête

torx

Rahmenanker mit Kopf

Torx



Info	Longueur	Qté/Emb	Code
	Länge	VPE	
ø 7,5 mm d1 = 11 mm TX30	60 mm	100	ABCRA7560MK
	80 mm	100	ABCRA7580MK
	100 mm	100	ABCRA75100MK
	120 mm	100	ABCRA75120MK
	150 mm	100	ABCRA75150MK
	180 mm	100	ABCRA75180MK
	210 mm	100	ABCRA75210MK

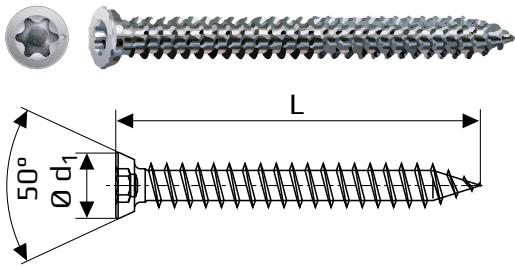

Fensterrahmenschrauben & rahmenanker

Vis châssis sans tête

torx

Rahmenanker ohne Kopf

Torx



Info	Longueur	Qté/Emb	Code
	Länge	VPE	
ø 7,5 mm d1 = 8 mm TX30	60 mm	100	ABCRA7560OK
	80 mm	100	ABCRA7580OK
	100 mm	100	ABCRA75100OK
	120 mm	100	ABCRA75120OK
	130 mm	100	ABCRA75130OK
	150 mm	100	ABCRA75150OK
	180 mm	100	ABCRA75180OK
	210 mm	100	ABCRA75210OK

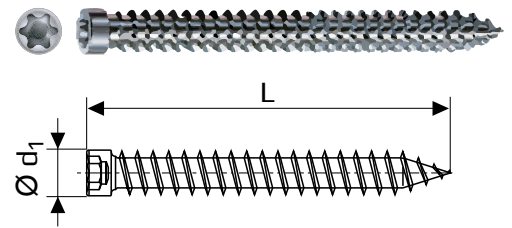

Vis châssis avec tête

torx

Rahmenanker mit Kopf

Torx



Info	Longueur	Qté/Emb	Code
	Länge	VPE	
ø 7,5 mm d1 = 12 mm TX30	52 mm	100	REIRA7552MK
	72 mm	100	REIRA7572MK
	92 mm	100	REIRA7592MK
	112 mm	50	REIRA75112MK
	132 mm	50	REIRA75132MK
	152 mm	50	REIRA75152MK
	182 mm	50	REIRA75182MK
	212 mm	50	REIRA75212MK
	252 mm	50	REIRA75252MK
	302 mm	50	REIRA75302MK

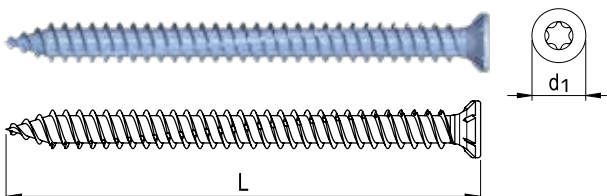

Vis châssis sans tête

torx

Rahmenanker ohne Kopf

Torx



Info	Longueur	Qté/Emb	Code
	Länge	VPE	
ø 7,5 mm d1 = 8 mm TX30	72 mm	100	REIRA7572OK
	92 mm	100	REIRA7592OK
	112 mm	50	REIRA75112OK
	132 mm	50	REIRA75132OK
	152 mm	50	REIRA75152OK
	182 mm	50	REIRA75182OK
	212 mm	50	REIRA75212OK
	252 mm	50	REIRA75252OK
	302 mm	50	REIRA75302OK

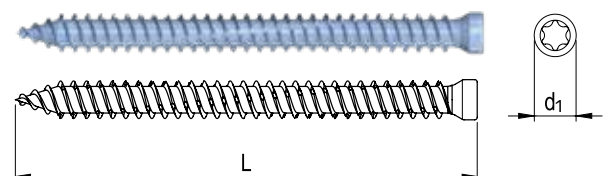

Vis pour Gyproc

Gyproc-Schrauben

Vis gyproc (bois ou OSB)

Filet gros, PH2

Gipsplattenschrauben (Holz oder OSB)

Grobgewinde, PH2



Info	Longueur	Qté/Emb	Code
	Länge	VPE	
ø 3,9 mm d1 = 8,4 mm PH2	25 mm	1000	REIVG3925FG01
	25 mm	100	REIVG3925FG02
	30 mm	1000	REIVG3930FG01
	30 mm	100	REIVG3930FG02
	35 mm	1000	REIVG3935FG01
	35 mm	100	REIVG3935FG02
	45 mm	1000	REIVG3945FG01
	45 mm	100	REIVG3945FG02
	55 mm	1000	REIVG3955FG01
	55 mm	100	REIVG3955FG02
ø 4,2 mm d1 = 8,4 mm PH2	65 mm	1000	REIVG4265FG01
	65 mm	100	REIVG4265FG02
	75 mm	1000	REIVG4275FG01
	75 mm	100	REIVG4275FG02
ø 5,0 mm d1 = 8,4 mm PH2	90 mm	1000	REIVG5090FG01
	90 mm	100	REIVG5090FG02

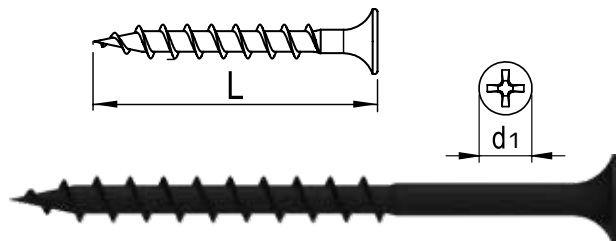

Vis gyproc (metal studs)

Filet fin, PH2

Gipsplattenschrauben (Metal Studs)

Feingewinde, PH2



Info	Longueur	Qté/Emb	Code
	Länge	VPE	
ø 3,9 mm d1 = 8,4 mm PH2	25 mm	1000	REIVG3925FF01
	25 mm	100	REIVG3925FF02
	30 mm	1000	REIVG3930FF01
	30 mm	100	REIVG3930FF02
	35 mm	1000	REIVG3935FF01
	35 mm	100	REIVG3935FF02
	45 mm	1000	REIVG3945FF01
	45 mm	100	REIVG3945FF02
	55 mm	1000	REIVG3955FF01
	55 mm	100	REIVG3955FF02
ø 4,2 mm d1 = 8,4 mm PH2	65 mm	1000	REIVG4265FF01
	65 mm	100	REIVG4265FF02
	75 mm	1000	REIVG4275FF01
	75 mm	100	REIVG4275FF02
ø 5,0 mm d1 = 8,4 mm PH2	90 mm	1000	REIVG5090FF01
	90 mm	100	REIVG5090FF02

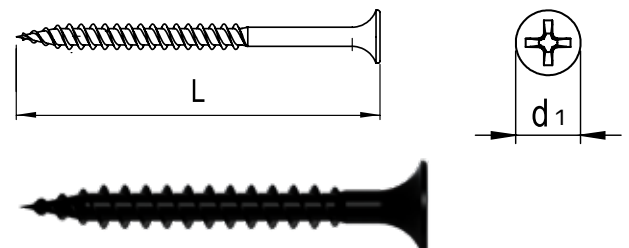

Vis pour panneaux Fermacell

Tête fraisé, torx

Schrauben für Fermacellplatten

Senkkopf, Torx



Info	Longueur	Qté/Emb	Code
	Länge	VPE	
ø 3,9 mm d1 = 8,4 mm PH2	19 mm	1000	REIVF391901
		200	REIVF391902
	22 mm	1000	REIVF392201
		200	REIVF392202
	30 mm	1000	REIVF393001
		200	REIVF393002
	45 mm	500	REIVF394501
		200	REIVF394502

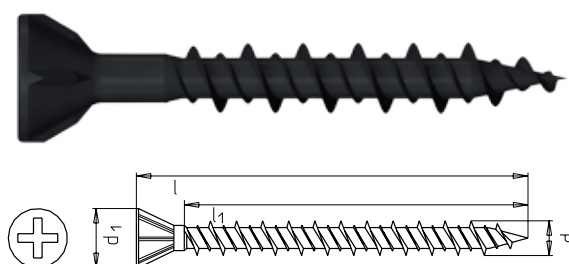

Vis sur bande pour plaques de plâtre sur bande (bois ou OSB)

Filet gros, PH2

Bandschrauben für Gipsfaserplatten (Holz oder OSB)

Grobgewinde, PH2



Info	Longueur	Qté/Emb	Code
	Länge	VPE	
ø 3,9 mm d1 = 8,4 mm PH2	25 mm	1000	72215002
	35 mm	1000	72215102
	45 mm	1000	72215202



Vis sur bande pour plaques de plâtre (metal studs)

Filet fin, PH2

Bandschrauben für Gipsfaserplatten (Metal Studs)

Feingewinde, PH2



Info	Longueur	Qté/Emb	Code
	Länge	VPE	
ø 3,9 d1 = 8,4 mm PH2	25 mm	1000	72215502
	35 mm	1000	722156
	45 mm	1000	72215702



Vis Fermacell

Tête fraisé, PH2

Fermacellschrauben

Senkkopf, PH2



Info	Longueur	Qté/Emb	Code
	Länge	VPE	
ø 3,9 mm d1 = 7 mm PH2	30 mm	1000	72215402
	45 mm	1000	722195



Vis sur bande pour plaques de plâtre (metal studs + bois ou OSB)

Filet fin, PH2

Bandschrauben für Gipsfaserplatten (Metal Studs + Holz oder OSB)

Feingewinde, PH2



Info	Longueur	Qté/Emb	Code
	Länge	VPE	
ø 3,9 d1 = 8,4 mm PH2	35 mm	1000	72217502



Code
ABCDRILL241

Foret étagé à deux niveaux 4,1 mm

Avec 2 niveaux de perçage de Ø 4,1 mm et Ø 6,5 mm



Stufenbohrer mit zwei Stufen 4,1 mm

Zwei Arbeitsschritte in einem: Bohrung mit 4,1 mm Durchmesser und anschließende Senkung mit einem Durchmesser von 6,5mm.

Set d'embouts BITcheck

Porte-embout avec entrée et sortie faciles.
Coffret attractif avec levier automatique.

BITcheck Set







Bit-Halter mit attraktivem Gehäuse.
Leichte Entnahme und Einsatz der Bits.



Code
ABCBITCHECK





Bits T-Star

Version courte, par 5 pièces
Kurzversion, pro 5 Stück

Descriptif	Code	
Beschreibung		
25 mm T10	ABCBITST10	
25 mm T15	ABCBITST15	
25 mm T20	ABCBITST20	
25 mm T25	ABCBITST25	
25 mm T30	ABCBITST30	
25 mm T40	ABCBITST40	

Bits T-Star

Version longue, par 5 pièces
Langversion, pro 5 Stück

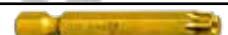
Descriptif	Code	
Beschreibung		
50 mm T10	ABCBITS1050MM	
50 mm T15	ABCBITS1050MM	
50 mm T20	ABCBITS1050MM	
50 mm T25	ABCBITS1050MM	
50 mm T30	ABCBITS1050MM	
50 mm T40	ABCBITS1050MM	



Coffret d'embouts longs 75 mm
Version longue, 18 pièces

Longbitbox 75 mm
18-teilig

Code
REI591102



Coffret d'embouts courts
Version courte, 32 pièces

Bitbox
32-teilig

Code
562003



Kit d'embouts
11 pièces

Universal Bit-Set
11-teilig

Code
KITEMBOUT

Bits cruciforme
Version courte, par 10 pièces

Bits cruciforme
Kurzversion, pro 10 Stück

Descriptif	Code
Beschreibung	
25 mm PZ1	REI069687
25 mm PZ2	REI069694
25 mm PZ3	REI069700
25 mm PH1	REI069717
25 mm PH2	REI069724



Bits Torx
Version courte, par 10 pièces

Bits Torx
Kurzversion, pro 10 Stück

Descriptif	Code
Beschreibung	
25 mm T10	REI069779
25 mm T15	REI069786
25 mm T20	REI069793
25 mm T25	REI069809
25 mm T30	REI069816
25 mm T40	REI069823



Votre étagère de vis adaptée à vos besoins Ihr Schraubenregal abgestimmt auf Ihren Bedarf

Choisissez vous-même le contenu de votre étagère parmi les produits que vous trouvez dans ce catalogue.

Personne de contact **SOUMAGNE** :

Renaud Joris

Tel. : 04 220 60 21

E-mail : renaud.joris@biemar.be

Wählen Sie selber den Inhalt ihres Regals unter den Produkten in diesem Katalog.

Kontaktperson **MALMEDY** :

David Sarlette

Tel. : 080 79 97 09

E-mail : david.sarlette@biemar.be



Téléchargez le formulaire de commande :
Laden Sie unser Bestellformular herunter :





Rue de la Clé, 57 4630 SOUMAGNE
Tél: 04 377 94 94 - Fax: 04 377 23 43

Route de Waimès, 90 4960 MALMEDY
Tél: 080 79 97 97 - Fax: 080 79 97 90

>> www.biemar.be
>> info@biemar.be

Suivez-nous sur:



Édition: 2020/09

Des conseils particulièrement pro.

FORMULAIRE DE COMMANDE ÉTAGÈRE À VIS

Client :

Date commande :

/ / 202

Référence :

Commande par :



Numéro article	Vis à bois R2 plus - tête fraisée, zingué blanc, acier	Quant.	Emb./bte
REIR2TX2050100TG	FP, 5,0 x 100, pointe antifendage	2	200
REIR2TX2050120TG	RN 9251,TX, FP, 5,0 x 120, pointe antifendage	2	200
REIR2TX205050TG	RN 9251,TX, FP, 5,0 x 50, pointe antifendage	2	500
REIR2TX205050VG	RN 9250,TX, FT, 5,0 X 50	2	500
REIR2TX205060TG	RN 9251,TX, FP, 5,0 x 60, pointe antifendage	2	200
REIR2TX205060VG	R2 plus,RN 9250,TX, FT, 5,0 X 60,	2	200
REIR2TX205070TG	RN 9251,TX, FP, 5,0 x 70, pointe antifendage	2	200
REIR2TX205080TG	RN 9251,TX, FP, 5,0 x 80, pointe antifendage	2	200
REIR2TX205090TG	RN 9251,TX, FP, 5,0 x 90, pointe antifendage	2	200
REIR2TX60100TG	RN 9251,TX, FP, 6,0 x 100, pointe antifendage	2	100
REIR2TX60110TG	RN 9251,TX, FP, 6,0 x 110, pointe antifendage	2	100
REIR2TX60120TG	RN 9251,TX, FP, 6,0 x 120, pointe antifendage	2	100
REIR2TX60130TG	RN 9251,TX, FP, 6,0 x 130, pointe antifendage	2	100
REIR2TX60140TG	RN 9251,TX, FP, 6,0 x 140, pointe antifendage	2	100
REIR2TX60150TG	RN 9251,TX, FP, 6,0 x 150, pointe antifendage	2	100
REIR2TX60160TG	RN 9251,TX, FP, 6,0 x 160, pointe antifendage	2	100
REIR2TX60180TG	RN 9251,TX, FP, 6,0 x 180, pointe antifendage	2	100
REIR2TX60200TG	RN 9251,TX, FP, 6,0 x 200, pointe antifendage	2	100
REIR2TX60220TG	RN 9251,TX, FP, 6,0 x 220, pointe antifendage	1	100
REIR2TX60240TG	RN 9251,TX, FP, 6,0 x 240, pointe antifendage	1	100
REIR2TX60260TG	RN 9251,TX, FP, 6,0 x 260, pointe antifendage	1	100
REIR2TX6070TG	RN 9251,TX, FP, 6,0 x 70, pointe antifendage	2	100
REIR2TX6080TG	RN 9251,TX, FP, 6,0 x 80, pointe antifendage	2	100
REIR2TX6090TG	RN 9251,TX, FP, 6,0 x 90, pointe antifendage	2	100



Inscrivez-vous à notre Newsletter - www.biemar.be

Edition: 2020/08



BESTELLFORMULAR SCHRAUBENREGAL

Kunde :

Bestelldatum :

/ / 202

Referenz :

Bestellt von :



Artikelnummer	Holzschraube R2 plus - Seknkkopf, weiß verzinkt, Stahl	Anzahl	St./Dose
REIR2TX2050100TG	FP, 5,0 x 100, pointe antifendage	2	200
REIR2TX2050120TG	RN 9251,TX, FP, 5,0 x 120, pointe antifendage	2	200
REIR2TX205050TG	RN 9251,TX, FP, 5,0 x 50, pointe antifendage	2	500
REIR2TX205050VG	RN 9250,TX, FT, 5,0 X 50	2	500
REIR2TX205060TG	RN 9251,TX, FP, 5,0 x 60, pointe antifendage	2	200
REIR2TX205060VG	R2 plus,RN 9250,TX, FT, 5,0 X 60,	2	200
REIR2TX205070TG	RN 9251,TX, FP, 5,0 x 70, pointe antifendage	2	200
REIR2TX205080TG	RN 9251,TX, FP, 5,0 x 80, pointe antifendage	2	200
REIR2TX205090TG	RN 9251,TX, FP, 5,0 x 90, pointe antifendage	2	200
REIR2TX60100TG	RN 9251,TX, FP, 6,0 x 100, pointe antifendage	2	100
REIR2TX60110TG	RN 9251,TX, FP, 6,0 x 110, pointe antifendage	2	100
REIR2TX60120TG	RN 9251,TX, FP, 6,0 x 120, pointe antifendage	2	100
REIR2TX60130TG	RN 9251,TX, FP, 6,0 x 130, pointe antifendage	2	100
REIR2TX60140TG	RN 9251,TX, FP, 6,0 x 140, pointe antifendage	2	100
REIR2TX60150TG	RN 9251,TX, FP, 6,0 x 150, pointe antifendage	2	100
REIR2TX60160TG	RN 9251,TX, FP, 6,0 x 160, pointe antifendage	2	100
REIR2TX60180TG	RN 9251,TX, FP, 6,0 x 180, pointe antifendage	2	100
REIR2TX60200TG	RN 9251,TX, FP, 6,0 x 200, pointe antifendage	2	100
REIR2TX60220TG	RN 9251,TX, FP, 6,0 x 220, pointe antifendage	1	100
REIR2TX60240TG	RN 9251,TX, FP, 6,0 x 240, pointe antifendage	1	100
REIR2TX60260TG	RN 9251,TX, FP, 6,0 x 260, pointe antifendage	1	100
REIR2TX6070TG	RN 9251,TX, FP, 6,0 x 70, pointe antifendage	2	100
REIR2TX6080TG	RN 9251,TX, FP, 6,0 x 80, pointe antifendage	2	100
REIR2TX6090TG	RN 9251,TX, FP, 6,0 x 90, pointe antifendage	2	100



Inscrivez-vous à notre Newsletter - www.biemar.be

Edition: 2020/08

